



नेपाल सरकार

प्रधानमन्त्री तथा मन्त्रिपरिषद्को कार्यालय

सिंहदरवार, काठमाडौं
नेपाल ।



पत्र संख्या :-

दि. नं. :-

म.सं. १३९१/२०२२

मिति: २०७६/१०/२०

सहरी विकास महाशाखा

दस्ता नं.:- २४६५

दस्ता मिति:- ०८०६/१९१०६५

सहरी विकास महाशाखा

सचिवालय मिति २०७६/१०/२०

दस्ता नं. २६६

दस्ता मिति २०७६/११/२

श्री सचिव,

सहरी विकास मन्त्रालय ।

नेपाल सहरी सडक मापदण्ड, २०७६ स्वीकृत गर्ने विषय मं.प.वै.सं. ४६/०७६ मिति २०७६/१०/२० को मन्त्रिपरिषद्को बैठकमा पेश हुँदा न्यसमा नेपाल सरकार, मन्त्रिपरिषदले देहायबमोजिम निर्णय गरेकोले सोबमोजिम कार्यान्वयन हुन नेपाल सरकार (कार्यसम्पादन) नियमावली, २०६४ को नियम २९, बमोजिम अनुरोध गरेको छु-

नेपाल सरकारको निर्णय-

"नेपाल सहरी सडक मापदण्ड, २०७६ स्वीकृत गर्ने विषयको सहरी विकास मन्त्रालयको नं. २९/२-०७६/२/१० को प्रस्ताव मं.प.वै.सं. ८/०७६ मिति २०७६/२/१० को मन्त्रिपरिषद्को बैठकमा पेश हुँदा "मन्त्रिपरिषद्, आर्थिक तथा पूर्वाधार समितिमा छलफल गरी पेश गर्ने" निर्णय भएअनुसार मिति २०७६/२/२७ मा बसेको मन्त्रिपरिषद्, आर्थिक तथा पूर्वाधार समितिको बैठकबाट परिमार्जन गरिएको यसैसाथ संलग्न "नेपाल सहरी सडक मापदण्ड, २०७६ (Nepal Urban Road Standard-2076)" को क्रमसङ्ख्या 1.2 Scope and Limitation मा रहेको urban express ways भन्ने व्यहोरापछि "highways sections in the urban areas" भन्ने व्यहोरा थप गरी अरु समितिबाट पेश भएबमोजिम स्वीकृत गर्ने ।"

५०६

लोकसेवा विभाग
मुख्यमन्त्री



Government of Nepal

Ministry of Urban Development

Singhadurbar, Kathmandu

Nepal Urban Road Standard- 2076

Approval Date: 2076/10/20 BS



A handwritten signature in black ink, located at the bottom left of the page.

A handwritten signature in black ink, located at the bottom right of the page.

Preface

As the subject matters of Highway and Traffic Engineering are well established and Nepal Road Standard-2070 (Second Revision) and Nepal Rural Road Standards-2055 (First Revision) are the prevailing road standards in the country. Nepal Urban Road Standard, 2076 is introduced with the objective of achieving consistency specifically in urban road design and construction. The focus of this standard is the urban area respecting the volume and composition of traffic focusing on pedestrian and non-motorized vehicle with the requirements for urban services e.g. water supply, sewage, drains, electricity, etc. Some references are drawn from the prevailing road standards to this standard.



Abbreviation

AADT	Annual Average Daily Traffic
AASHTO	American Association of State Highway and Transportation Officials
ADT	Average Daily Traffic
ASTM	American Society of testing and Materials
BC	Bearing Capacity
BS	Bikarm Sambat
BSCP	British Standard Code of Practice
CBD	Central Business District
CE	Common Era
DHV	Designing Hour Volume
DOLI	Department of Local Infrastructure
DOR	Department of Road
DUDBC	Department of Urban Development and Building and Construction
GoN	Government of Nepal
HFL	High Flood Level
IP	Intersection Point
IRC	Indian Road Congress (i.e. Recommended Code of Practice by IRC)
IS	Indian Standards
ISO	International Organization for Standardization
LOS	Level of Service
MoUD	Ministry of Urban Development

MoPIT	Ministry of Physical Infrastructure and Transport
NMV	Non-Motorized Vehicle
NRS	Nepal Road Standard
NS	Nepal Bureau of Standard
PCU	Passenger Car Unit
PHV	Pick Hour Traffic Volume
RCC	Reinforced Cement Concrete
SD	Sight Distance
SSD	Stopping Sight Distance
SRN	Strategic Road Network
MT/T	Metric Ton = 10 ³ kg
TU	Transport Unit
WC	Wearing Course

Contents

Preface.....	i
Abbreviation.....	ii
1. Introduction.....	1
1.1 Background.....	1
1.2 Scope and Limitation.....	1
1.3 Reasons for Standardization of Urban Roads.....	1
1.3.1 Present status of Road.....	1
1.3.2 Expected Output.....	2
1.4 Classification of Urban Roads.....	2
2. Elements of urban road.....	5
3. Elements of Design of urban road.....	5
3.1 General Consideration.....	5
3.2 General Design Principle.....	6
3.3 Sight Distance.....	6
3.3.1. Stopping Sight Distance.....	6
3.3.2. Decision Sight Distance.....	7
3.3.3. Headlight Sight Distance.....	7
3.4 Design Traffic Volume and Capacity.....	7
3.5 Traffic Characteristics and Equivalency Factors.....	8
3.6 Vertical Alignment.....	9
3.6.1 Vertical Curves.....	9
3.6.2 Summit Curves.....	10
3.6.3 Valley Curves.....	11
3.7 Horizontal Alignment.....	12
3.7.1. Supper Elevation.....	13
3.7.2. Minimum Curve Radius.....	14
3.7.3. Set-back Distance at Horizontal Curves.....	15
3.7.4. Transition Curves.....	16
3.7.5. Widening of Carriageway on Curves.....	18
3.8 Gradient.....	18
3.9 Design Speed.....	19
3.10 Utilities.....	19
3.10.1 Street Lighting.....	20
3.10.2 Storm Water Drainage.....	21
3.10.3 Underground utilities.....	21
3.11 Clearances.....	22
3.11.1. Lateral Clearance.....	23
3.11.2. Vertical Clearance.....	23

3.12 Traffic Control Devices	23
4. Cross sectional Element	24
4.1 Right of Way	24
4.2 Carriageway Width.....	24
4.3 Footpath.....	25
4.4 Cycle Track	26
4.5 Medians & Pedestrian Refuges	27
4.6 Verge	27
4.7 Parking Lane	28
4.8 Bus-bays & Bus stops.....	28
4.9 Kerbs	29
4.11 Pedestrian Crossing	29
4.12 Traffic Calming Elements	30
4.13 Bus Rapid Transit (BRT).....	30
4.14 Landscaping Design & Aesthetics.....	31
4.15 Grade separated Junctions & Facilities	31
4.15.1 Pedestrian Subway	32
4.15.2 Pedestrian Overhead Bridges.....	32
4.15.3 Grade Separated NMV Crossing	33
4.15.4 Grade separated Vehicular Junctions	35
5. Additional Consideration for Strategic Road passing through Urban Road	35
5.1 Noise barriers	35
5.2 Light barriers	35
5.3 Approach Facilities.....	35
5.4 Crossing Facilities	36
5.5 Consistency of Standards	36
5.6 Relaxation of Road Design Standard.....	36
6. Glossary.....	37
7. References	41



List of Table

Table 1: Values of 'f' for Design	6
Table 2: Stopping Sight Distance value for Different Speeds	6
Table 3: Decision Sight Distance for Advance Man oeuvres	7
Table 4: Passenger car unit (PCU).....	8
Table 5: Traffic Capacity	9
Table 6: Minimum Length of Vertical Curves	9
Table 7: Radii beyond which Super Elevation is not required	13
Table 8: Minimum Radius of.....	15
Table 9: Length of the Transition Curve	17
Table 10: Extra width of Pavement at Horizontal Curves	18
Table 11: Maximum critical Length of Grade	19
Table 12: Recommended Minimum Gradient	19
Table 13: Recommended Design Speeds for Different Classes of Urban Roads	19
Table 14: Light pole height and spacing.....	21
Table 15: Broad recommendation about depth of laying (denoting the bottom of trench) of the various service line :	22
Table 16: Right of Way Width.....	24
Table 17: Recommended Carriage Width	24
Table 18: Capacity of Footpaths	26
Table 19: Capacity of Cycle Tracks	26
Table 20: Recommended Camber.....	29

List of Figure

Figure 1: Typical Arterial Road Sections	3
Figure 2: Typical Sub-Arterial Road Sections	4
Figure 3: Typical Collector Road Section	4
Figure 4: Typical Local Road Section.....	5
Figure 5: Summit Curve.....	10
Figure 6: Length of Summit Curve for Stopping Sight Distance	11
Figure 7 Valley Curve	11
Figure 8: Length of Valley Curve	12
Figure 9: Supper Elevation	13
Figure 10: Values of Super Elevation	14
Figure 11: Radius of Horizontal Curve.	15
Figure 12: Transition Curve	16
Figure 13: Elements of combined Circular and Transition Curve	16

1. Introduction

1.1 Background

Nepal Urban Road Standards-2076 (NURS-2076) shall apply to all urban roads being constructed within the urban areas of Nepal. These standards may be relaxed by Government of Nepal to meet special circumstances. Road network is the major urban infrastructure in terms of its required financial resources, land consumption and land-use planning in the urban area. Furthermore, the aesthetic appearance of the city is mainly dependent on the urban road pattern. The growth of the urban area is mainly guided by the urban road hierarchy and their alignment.

In this context, growing urbanization in Nepal is major challenge for the urban planner as well as municipal authorities. Such situation has created a challenging situation for safe movement of vulnerable road user specially the pedestrians and non-motorized vehicles leading to poor road safety situation. The recent situation demands safer travel and accessibility to all while considering the urban mobility. The urban mobility and accessibility mainly depend upon the urban road network planning and their technical parameters. With the objectives of achieving consistency in road design and construction, Nepal Road Standard (NRS) was introduced. According to four administrative classification given in Nepal Road Standard-2070, urban road is one of them but, these standards were applicable only for the design of strategic roads and are not applicable to address all the urban needs. Therefore, it became very essential to develop the 'Nepal Urban Road Standard'.

The standard incorporates major technical as well as planning aspects for urban roads. Classifications of urban roads, design criteria, elements of cross section, clearance etc., are major parts of this standard.

1.2 Scope and Limitation

This standard is applicable to roads or streets in urban areas as well as for small town and suburban areas. This standard does not cover standards for urban express ways, highways sections in the urban areas, strategic and rural road networks. This standard includes major elements of geometric design for urban roads. However, layout of junctions and their design parameters are not included in this standard.

1.3 Reasons for Standardization of Urban Roads

1.3.1 Present status of Road

The urban road networks, as seen in the urban areas, are of uneven type. Since the roads are being constructed by different governmental bodies, there is no uniformity in section for each type of road as each agency has its own standards.

The traffic lanes are also not defined and highly mismanaged. The roads especially the footpaths are encroached by the street vendors, parking and other amenities.

Lack of parking space in the urban areas led to the parking of vehicles on the roads itself which further shrinks already existing road. This results in the congestion and ultimately traffic jams.

Another distinctive feature is the footpath which is either absent or provided inappropriately in the network. All the street utilities like railings, street lights etc are installed directly on the footpath irrespective of its available clear width.

The present road network does not consider non vehicular traffic movement. While in designing stage, the access for the differently-able person along with movement for the non motorized vehicles should also be accommodated.

The absence of the above mentioned features urge to establish a standardized road network. Hence it becomes a prime necessity to publish a common Urban Road Standard which could be referred by any type of agency/professionals interested to build the road network within the urban areas.

1.3.2 Expected Output

After the implementation of Nepal Urban Road Standard, followings results shall be ensured.

1. Uniformity in all road sections.
2. Defined and dedicated lane system for all types of vehicles
3. Pedestrian friendly footpath
4. Consideration for non vehicular movement
5. Sufficient footpath for pedestrians and utilities

1.4 Classification of Urban Roads

For the purpose of geometric design urban roads are classified into four categories considering function of the road and traffic level.

- a) Arterial roads (*Path*)
- b) Sub-arterials roads (*Sadak*)
- c) Collector roads (*Marg*)
- d) Local roads (*Upa-Marg*)

Functions of different categories of roads are given below.

a) Arterial roads (*Path*)

These roads are generally meant for thorough traffic usually on a continuous route. These along with expressways (where they exist), serve as the principle network for through traffic flow. Significant intra-urban travel such as between CBD and outlying residential area or between major sub-urban centers is served by this facility. Parking, loading and unloading activities are generally restricted and regulated. Pedestrians are allowed to cross only at intersections or at the designated crossings. These roads generally are spaced at less than 1.5 km in highly developed central business areas and

at 8 km or more in sparsely developed urban fringes. Typical sections of Arterial are shown in the figures given below:

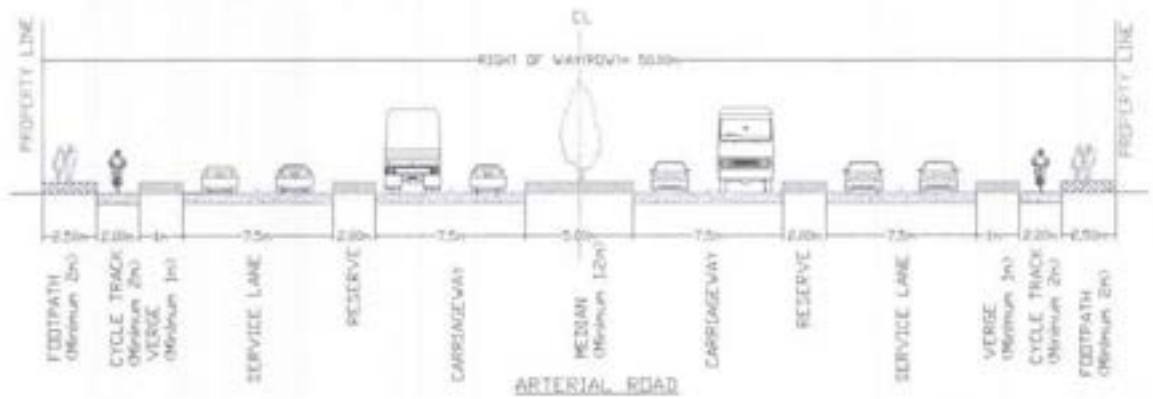
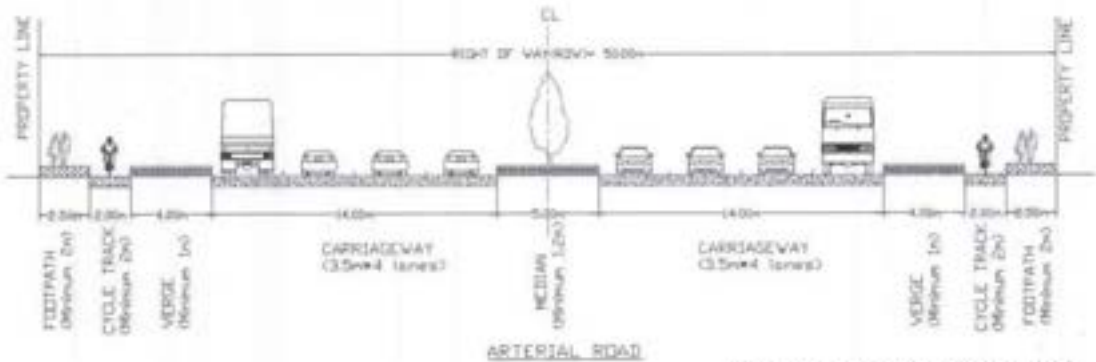

Figure 1: Typical Arterial Road Sections

ARTERIAL ROAD SECTION OPTION 1



ARTERIAL ROAD SECTION OPTION 2

b) Sub-arterial roads (*Sadak*)

These are roads of somewhat lower level of travel mobility than the arterial roads. The emphasis on access to adjoining area is more in case of these roads than in case of arterial roads. Parking loading and unloading are usually restricted and regulated. There spacing varies from about 0.5 km in CBD to 3.5 km to 5 km in the suburban fringe. Pedestrians are allowed to cross only at intersections or at the designated crossings. Typical sections of Sub-Arterial Road are shown in the figures given below:

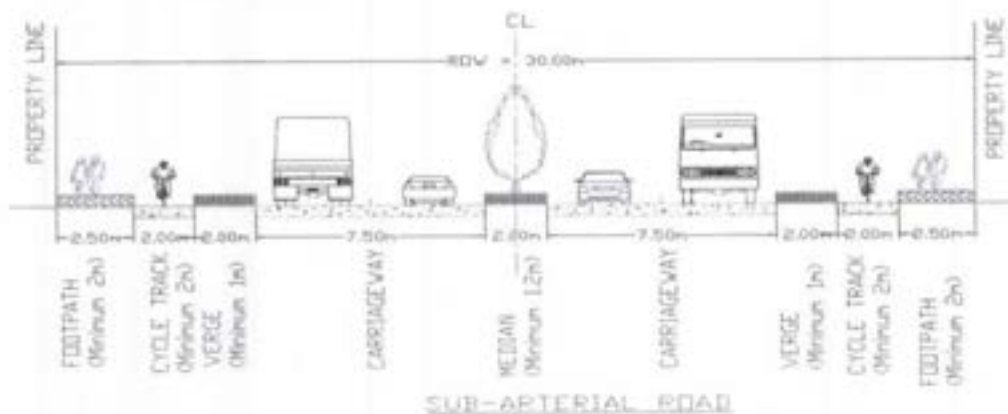

SUB ARTERIAL ROAD SECTION OPTION 1

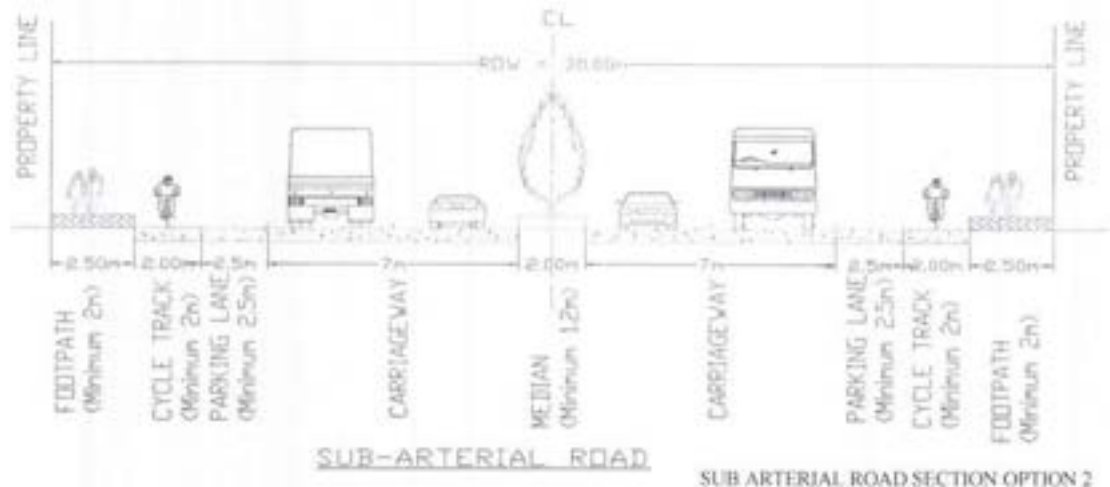

Figure 2: Typical Sub-Arterial Road Sections

c) Collector road (Marg)

A collector road is one intended for collecting and distributing the traffic to and from local roads and also for providing access to arterial/sub-arterial road. They may be located in residential neighborhoods, business areas and industrial areas. Normally full access is allowed on these roads from abutting properties. Typical section of Collector Road is shown in the figure given below:



Figure 3: Typical Collector Road Section

d) Local road (Upamarg)

A local road is one primarily intended for access to residence, business or other abutting property. Such a road normally does not carry large volume of traffic. The traffic carried either originates or terminates along its length. A local road may be residential, commercial or industrial, depending upon the prominent use of the adjoining land. Typical section of Collector Road is shown in the given figure:



Figure 4: Typical Local Road Section

2. Elements of urban road

While planning or designing urban road, focus shall be made not only to develop carriage way but to provide essential elements. Therefore, following elements shall be considered at least in built up area if there is availability of land.

- Carriage way
- Foot path/Walk way
- Cycle track
- Street light
- Utility space (under-ground or above the ground depending on space)
- Signage, and
- Other essential road furniture

3. Elements of Design of urban road

3.1 General Consideration

The principle factors to be considered in designating roads into appropriate system are the travel desire lines of people by various modes of transportation, the access needs of adjacent land, network pattern, and existing and proposed land-use.

In designing a road in urban areas, besides the classification of roads, other factors like type of traffic, effect on environment, drainage and maintenance etc needs to be given prime consideration. For example, mixed slow moving traffic requires careful consideration of grades, climbing lanes and curvature etc. Consideration should also be given to make the road and its structure blend with environment and produce a pleasing appearance. Noise and fume pollution is a problem in urban areas and cross section should provide for remedial measures such as noise barriers, and adequate distance should be kept between busy routes and populated areas. Since idling engines and slow motor vehicles have higher deleterious emissions, arterial roads should be designed for least stoppages. Design also take care of drainage, erosion control, space for services and for erecting signs, lighting posts, etc.

3.2 General Design Principle

Urban roads should be planned and designed to:

- provide safe, short and fast thoroughfare and access to all road users, being motor vehicles, cyclists and pedestrians;
- convey clearly the primary function to road users and encourage appropriate driver behavior;
- deliver traffic volumes at speeds compatible with function;
- provide convenient location for services;
- provide an opportunity for landscaping;
- allow for parking, where appropriate;
- have due regard to topography, geology, climate, environment and heritage of the site;

The appropriate design criteria for an urban road largely depend on a set of economic indicators, namely costs of construction and operation on one side, and the financial benefits to the community on another. These are strategic parameters that influence a decision to build a road. Economic analysis, in conjunction with the traffic analysis, determines the functional class of the road and the design speed.

3.3 Sight Distance

The following aspects of sight distance are important while designing alignment:

- a) The sight distance needed for stopping
- b) The sight distance needed for the passing of overtaken vehicles
- c) The sight distance needed for decision at complex locations

The coefficient of friction f depends on several factors such as type and condition of pavement surface and tires. Also the value of f decrease with increase in speed. The recommended values of ' f ' for design is as follows:

Table 1: Values of ' f ' for Design

Speed Kmph	10 to 30	40	50
Longitudinal Coefficient of Friction, f	0.4	0.38	0.37

3.3.1. Stopping Sight Distance

Stopping sight distance is the distance ahead needed by a driver to bring the vehicle to a complete stop before meeting a stationary object in his path. Stopping sight distance for various speeds are given in the below table:

Table 2: Stopping Sight Distance value for Different Speeds

Design Speed (km/h)	Lag Distance (m)	Braking Distance (m)	Stopping Sight Distance	
			Calculated (m)	Design (m)
10	6.9	1.0	7.9	10

20	13.9	3.9	17.8	20
30	20.8	8.8	29.7	30
40	27.8	16.6	44.3	45
50	34.7	26.6	61.3	65

3.3.2. Decision Sight Distance

The decision sight distance is distance required for driver to detect an unexpected or otherwise difficult to perceive information source or hazard in a roadway environment that may be visually cluttered, recognize a hazard or its threat potential, select an appropriate speed and path, and initiate and complete the required maneuver safely and efficiently.

Table 3: Decision Sight Distance for Advance Maneuvers

Design Speed	Decision Sight Distance (m)	
	A	B
10	25	40
20	55	80
30	85	120
40	120	160
50	155	195

Where,

A: Decision Sight Distance to stop on Urban Road

B: Decision Sight Distance to Speed/path/direction change on Urban Road

3.3.3. Headlight Sight Distance

On valley curves the design must ensure that the roadway ahead is illuminated during night travel by vehicle headlights for a sufficient length which enables the vehicle to break to a stop, if necessary. This is known as the headlight sight distance and is equal to the safe stopping distance. From safety considerations, valley curves should be designed to provide for this visibility. For designing valley curves, the following criteria should be followed to ensure the headlight sight distance:

- Height of headlight above the road surface is 0.75 m,
- The useful beam of headlight is one degree upwards from the grade of the road,
- The height of the object is nil.

3.4 Design Traffic Volume and Capacity

The road width should be designed to accommodate the design traffic volume. Past counts and consideration and of future development of urban areas must be kept in view while selecting the cross-section of roads. Estimation of future traffic volumes may be based on a simple projection of current volumes extrapolated from past trends, or on the basis of results of transportation study which allows change in land-use and accounts for socio-economic factors. The road should be designed to accommodate the traffic volumes computed for the end of design life. A design period of 15-20 years

should be adopted for arterials and sub- arterials and 10-15 years for local and collector streets. A higher design period should be taken for small towns and a lower design period for large cities. For high volume streets and busy intersections peak hour volumes should be used to determine the widths. For rough estimate, the peak hour flow may be taken as 10-12 percent of the daily flow.

3.5 Traffic Characteristics and Equivalency Factors

Traffic in urban areas is of mixed nature. The width requirements should be assessed on the basis of equivalent passenger car units (PCU) using the tentative equivalency factors shown in table below.

Table 4: Passenger car unit (PCU)

S	Vehicle Type	Equivalency
1	Motorcycle, Bicycle, Porter	0.5
2	Car, Auto Rickshaw, SUV, Light Van, Pick	1.0
3	Light (Mini)Truck, Tractor, Rickshaw	1.5
4	Truck, Bus , Minibus, Tractor with trailer	3.0
5	Non-motorized carts	6.0

In general, road design takes into account the peak hour traffic volume (PHV). The PHV is the heaviest traffic volume that passes a certain point of a lane in one hour. However, since for economic reasons, it is not possible to design roads in terms of the highest PHV, the tendency in most countries is to adopt the 30th PHV or, as in India, the 60th to 80th PHV. The significant measure of traffic volume is the designing hour volume (DHV) which can be determined by multiplying the ADT by a representative percentage. The DHV is measured by the number of vehicles per hour passing a certain selected point on a lane. Generally, the adjustment factor by which the ADT is multiplied to derive the DHV is 0.15. Thus,

$$DHV = ADT \times 0.15 \dots\dots\dots \text{Equation 1}$$

In this case the ADT is the projected value and is expressed in terms of Passenger Car Unit (PCU). Usually, the DHV is calculated as two-way volume.

The above formula for calculating DHV is useful only when the value of ADT is available; however, when there are incomplete values of the ADT, then the DHV cannot be calculated. In such cases, either the 30th or the 60th to 80th PHV may be taken as DHV.

Tentative practical capacities for both unidirectional and two-directional flows of urban roads between junctions are given table 5 below.

Table 5: Traffic Capacity

No. of traffic lanes and width	Traffic flow	Capacities in PCUs per hour for various traffic conditions		
		Roads with no frontage access, no standing vehicles, very little cross traffic	Roads with frontage access but no standing vehicle and high capacity intersections	Roads with free frontage access, parked vehicles and heavy cross traffic
1-Lane(3.5-4.0m)	One way	750	700	650
2-lane(7-7.5m)	One way	2400	1500	1200
	Two way	1500	1200	750
3-lane (10.5m)	One way	3600	2500	2000
4-lane (14.0m)	One way	4800	3000	2400
	Two way	4000	2500	2000
6-lane (21.0m)	One way*	3600	2500	2200
	Two way	6000	4200	3600

* For three lanes in predominant direction flow.

3.6 Vertical Alignment

Vertical alignment in urban areas is governed by need to match building line and entrance line levels and levels of intersection and median openings.

3.6.1 Vertical Curves

Vertical curves are introduced for smooth driving at grade changes. The vertical curves used in road design may be classified into two categories.

- Summit curves or crests curves with convexity upward
- Valley or sag curves with convexity downward

Vertical curves should be provided at all grade changes exceeding those indicated in table 6. For satisfactory appearance, the minimum length should be as shown in table 6 between changing grade lines.

The minimum lengths of curves and maximum grade change without a vertical curve are shown in table 6.

Table 6: Minimum Length of Vertical Curves

Design Speed, km/h	Maximum Grade Change (%) not requiring a Vertical Curve	Minimum Length of Vertical Curve (m)
10	1.8	10
20	1.6	12



30	1.5	15
40	1.2	25
50	1.0	30

3.6.2 Summit Curves

Summit curves in urban areas should be designed for safe stopping sight distance and they should be coordinated horizontal curvature. Broken-back profiles should be avoided and wherever possible, approaches to bridges less than 30 m width should be designed to fit a single vertical curve. The problem in designing the summit curve is to provide adequate sight distances. The SSD should be provided to all section of the road system.

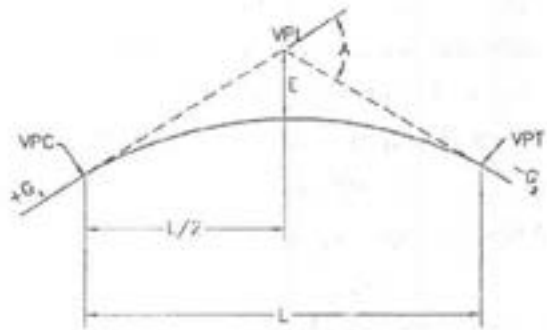

Figure 5: Summit Curve

Simple parabolic curve is used as the summit curve due to the following reasons:

- Parabola is very easy for arithmetical manipulation for computing ordinates
- Use of simple parabola as summit curve is found to be good riding comfort

Length of summit curve should be calculated on the basis of the following formulae:

- When the length of curve exceeds the required sight distance i.e. greater than S ($L > S$)

$$L = \frac{NS^2}{4.4} \dots \dots \dots \text{Equation 2}$$

Where, N = deviation angle (algebraic difference between two grades)

L = Length of vertical curves in meter

S = sight distance in meter equal to stopping distance

- When the length of the curve is less than the required sight distance i.e. L is less than S. ($L < S$)

$$L = 2S - \frac{4.4}{N} \dots \dots \dots \text{Equation 3}$$

The minimum length of summit curves for stopping sight distance and various deviation angles have been calculated and given in figure 4.1. Summit curves shall be square parabola ($y = ax^2$) and minimum length should not be less than that given in figure 6.

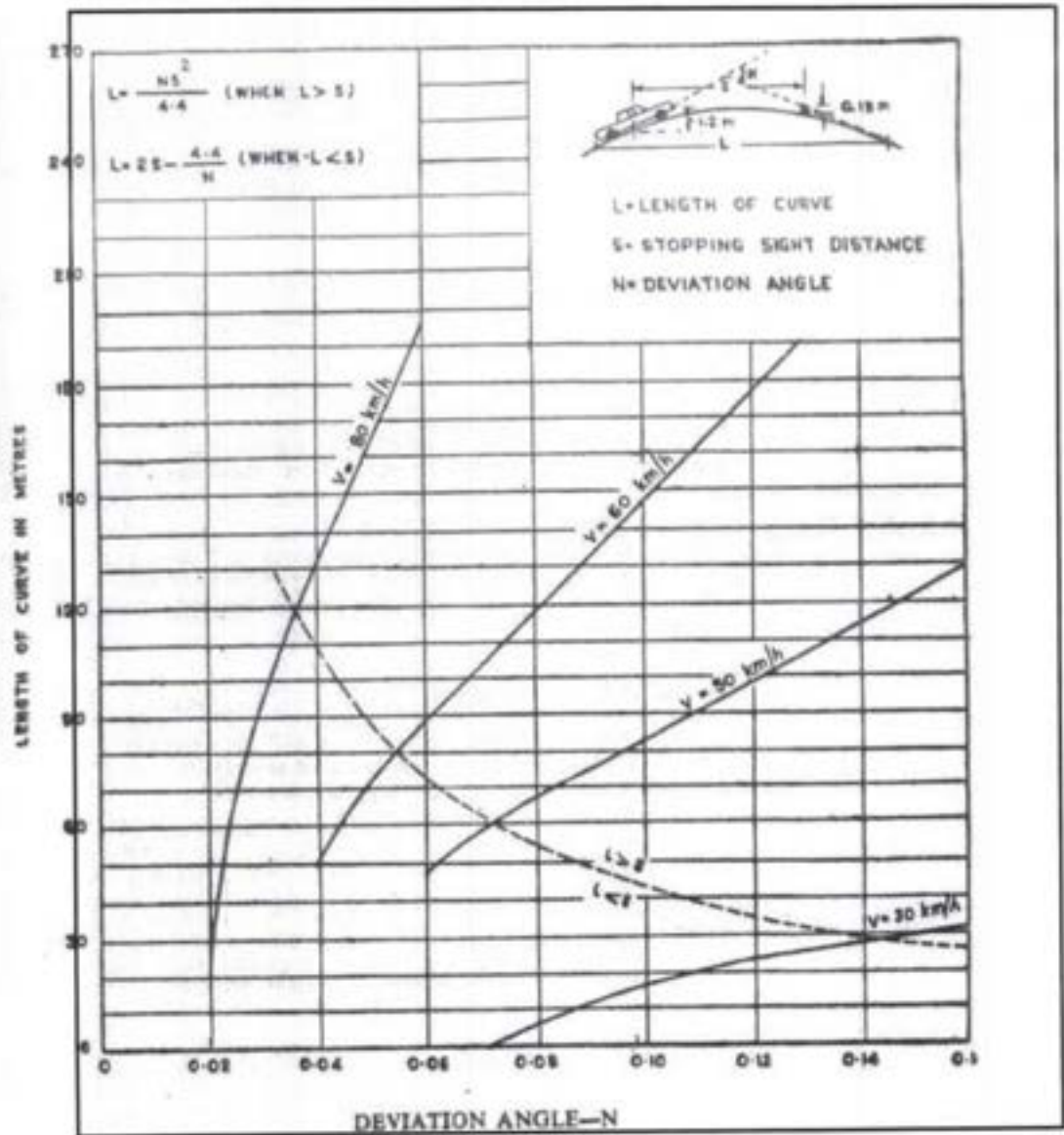

Figure 6: Length of Summit Curve for Stopping Sight Distance

3.6.3 Valley Curves

Valley curves on unlighted urban roads should be such that for night travel the headlight beam distance is the same as the stopping sight distance. In accordance with this criterion, the length of the curve may be calculated as:



- a) When the length of curve exceeds the sight distance

$$L = \frac{NS^2}{1.5 + 0.035S} \dots \dots \dots \text{Equation 4}$$

Figure 7: Valley Curve

b) When the length of curve is less than the required sight distance

$$L = 2S - \frac{1.5 + 0.035S}{N} \dots \dots \dots \text{Equation 5}$$

The length of the curves for various values of sight distance and deviation angle have been calculated as per above formulae and given in figure 8.

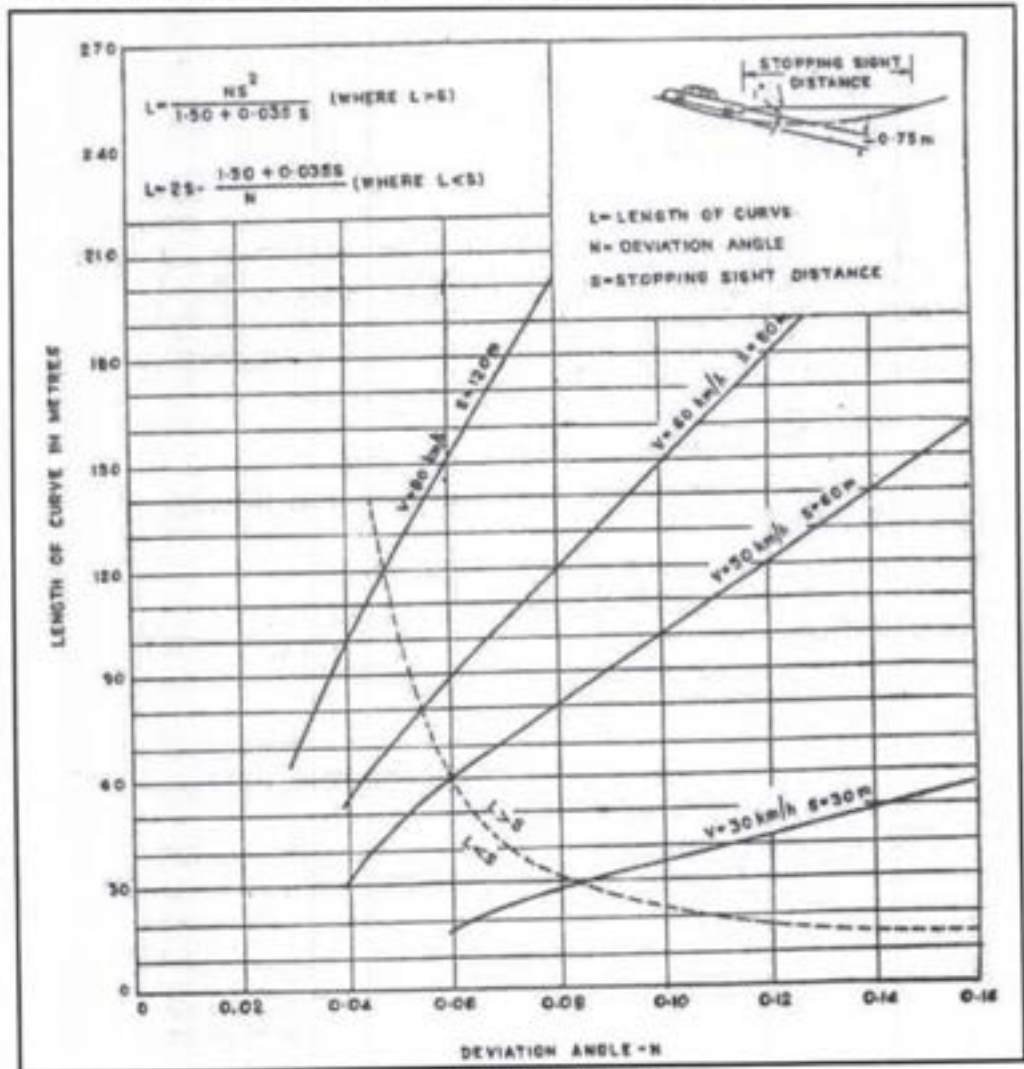

Figure 8: Length of Valley Curve

3.7 Horizontal Alignment

Horizontal alignment should enable safe and smooth movement of vehicles operating at design speed. It should be so designed that it has minimum disturbance to the landscape. As a normal rule, sharp curves should not be introduced at the end of long tangent, which can be hazardous.

In general, horizontal curves should consist of a circular portion flanked by spiral transitions at both ends. Design speed, super elevation and coefficient of side friction



affect the design of circular curves. Length of transition curves is determined on the basis of rate of change of centrifugal acceleration and super elevation.

3.7.1. Super Elevation

The super elevation is provided to maintain the design traffic speed at a given radius. Super elevation required on horizontal curves should be calculated from the following formula. This assumes the centrifugal force corresponding to three-fourth the design speed is balanced by super elevation and rest counteracted by side friction:

$$e = \frac{v^2}{225R} \dots \dots \dots \text{Equation 6}$$

Where, V is the speed in Km/h and R is the radius of the curve.

Super elevation obtained from the expression should be limited to 7 percent. However, on the urban sections with frequent intersections, it will be desirable to limit the super elevation to 4 percent for convenience in construction and for facilitating easy and safe turning movement of vehicles.

Radii beyond which no super elevation is required: when the value of the super elevation obtained from the above equation is less than the road camber, the normal cambered section should be continued on the curved portion without providing any super elevation.

Table 7: Radii beyond which Super Elevation is not required

Design Speed, km/h	Radius (m) for Cambered of			
	3%	2.50%	2%	1.70%
10	15	20	25	30
20	60	70	90	110
30	130	160	200	240
40	240	285	350	420
50	370	450	550	650

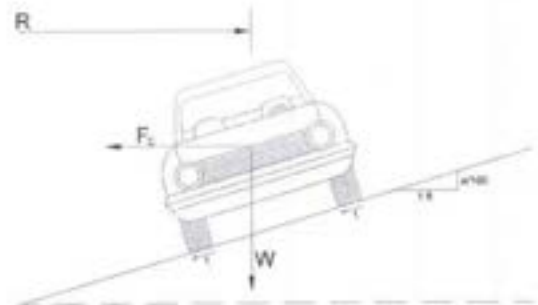

Figure 9: Supper Elevation

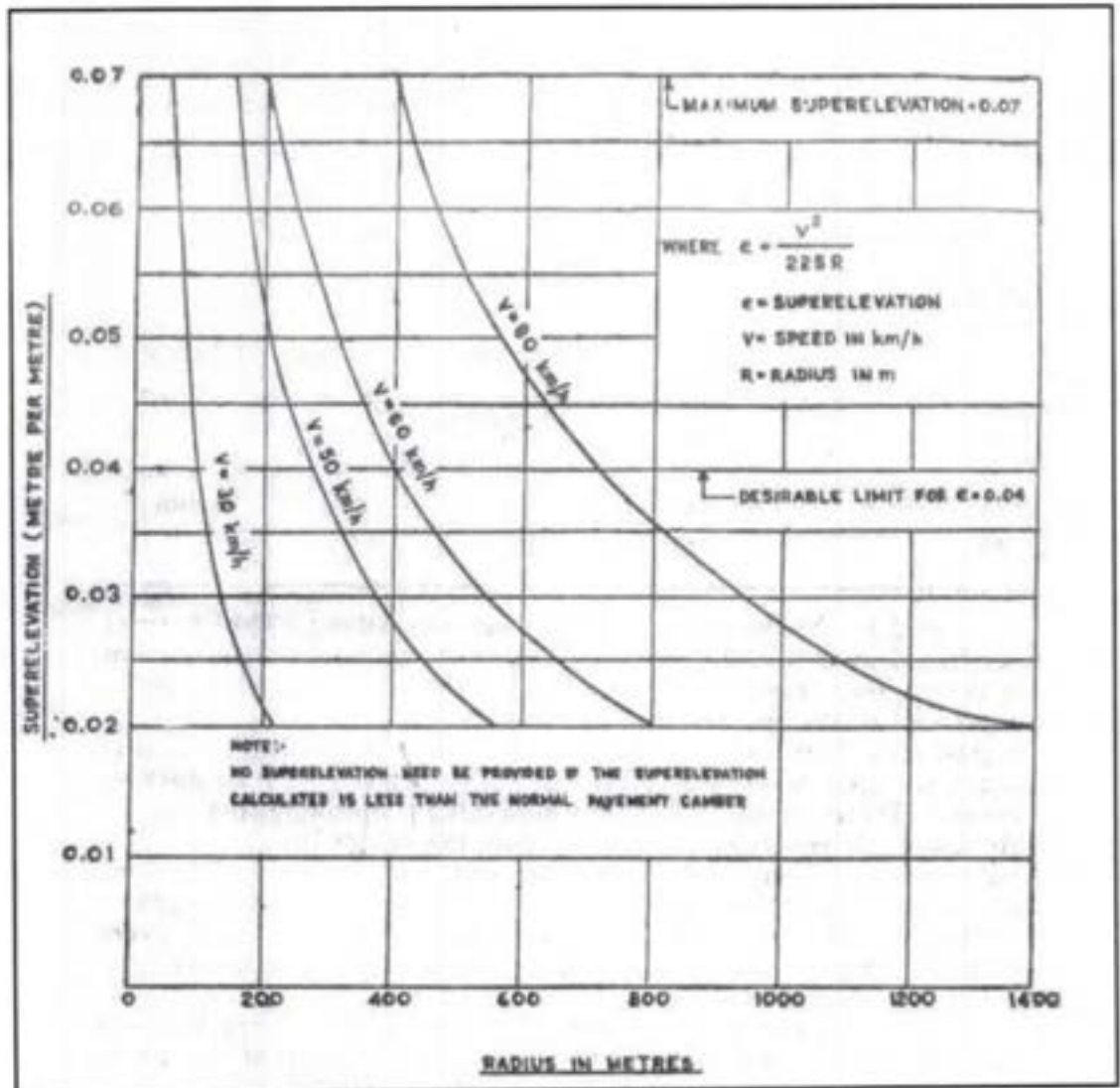

Figure 10: Values of Super Elevation

3.7.2. Minimum Curve Radius

On a horizontal curve, the centrifugal force is balanced by effects of super elevation and side friction. The following formula fulfils the condition of equilibrium:

$$e + f = \frac{v^2}{127R} \text{ or } R = \frac{v^2}{127(e+f)} \dots \dots \dots \text{Equation 7}$$

Where, V = Design speed, km/hr

R = Radius of the horizontal curve, m

e = Super elevation ratio, meter per meter

f = Coefficient of slide (lateral) friction between the vehicle tires and pavement surface. Constant value 0.15 coefficient of slide friction is adopted

Speed (km/h)	Minimum Radius (m) when Super elevation is limited to	
	7%	4%
10	9	9
20	15	20
30	30	40
40	60	70
50	90	105

Table 8: Minimum Radius of Horizontal Curve

3.7.3. Set-back Distance at Horizontal Curves

Adequate sight distance should be available across the inside of horizontal curves. Distance from the road center line within which the obstructions should be cleared to ensure the needed visibility i.e. the "set-back distance", can be calculated from geometrical considerations as shown in Figure- 4.

The set-back distance is calculated as follows:

$$m = R - (R - n) \cos \theta \dots \dots \dots \text{Equation 8}$$

Where, $\theta = \frac{S}{2(R - n)}$ radians

- m - Minimum set-back distance to sight obstruction in meters (measured from the center line of the road)
- R - Radius at the center line of the road in meters
- n - distance between the center line of the road and the center line of the inside lane in meters
- S - Sight distance in meters (measured along the center line of the road)

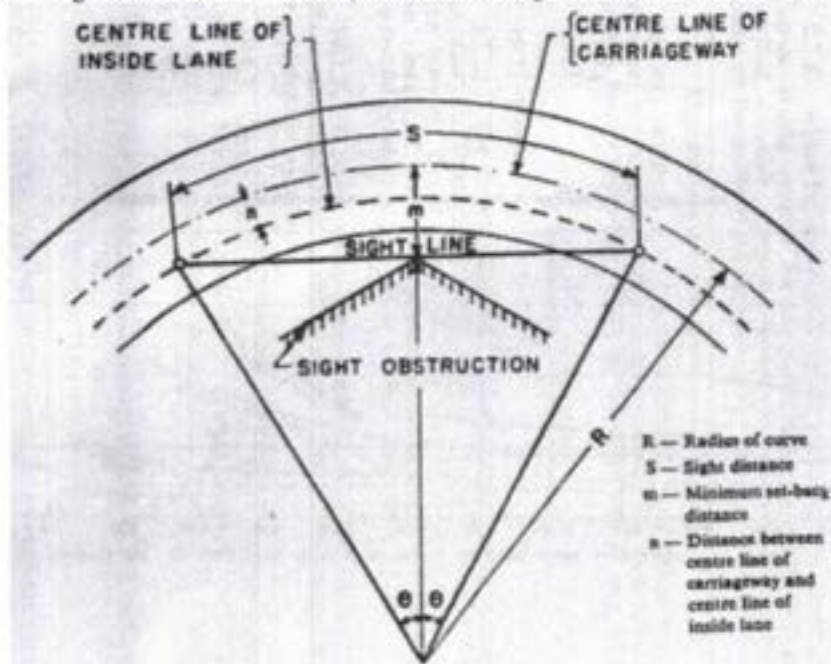

Figure 11: Radius of Horizontal Curve.



3.7.4. Transition Curves

Transition curves are necessary for a vehicle to have smooth entry from a straight section into a circular curve. The transition curves also improve aesthetic appearance of road besides permitting gradual application of the super elevation and extra widening of carriageway needed at horizontal curves. Spiral curves should be used for this purpose. Minimum length of transition curve should be determined from the following two considerations and largest of the two values adopted for design.

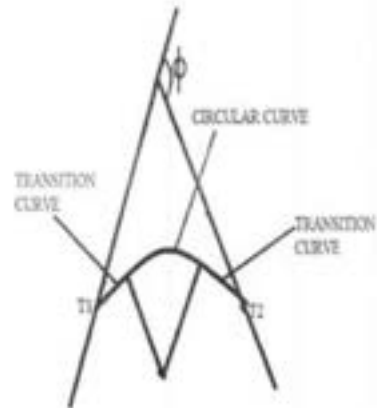

Figure 12: Transition Curve

i. The rate of change of centrifugal acceleration should not cause discomfort to drivers. From this consideration, the length of transition curve is given by:

$$L_s = \frac{0.0215V^3}{CR} \dots\dots\dots \text{Equation 9}$$

Where, L_s = length of transition curve in m.

V = Speed in km/h

R = radius of circular curve in m.

$$C = \frac{80}{75+V} \text{ (Subject to max of 0.8 and min of 0.5)}$$

ii. Rate of Change of super elevation (i.e. the longitudinal grade developed at the pavement edge compared to through grade along the centre line) should be such as not to cause discomfort to travelers or to make the road appear unsightly. This rate of change should not be steeper than 1 in 150. The formula for minimum length of transition curve on this basis with super elevation limited to 7 percent works out to:

$$L_s = \frac{2.7V^2}{R} \dots\dots\dots \text{Equation 10}$$

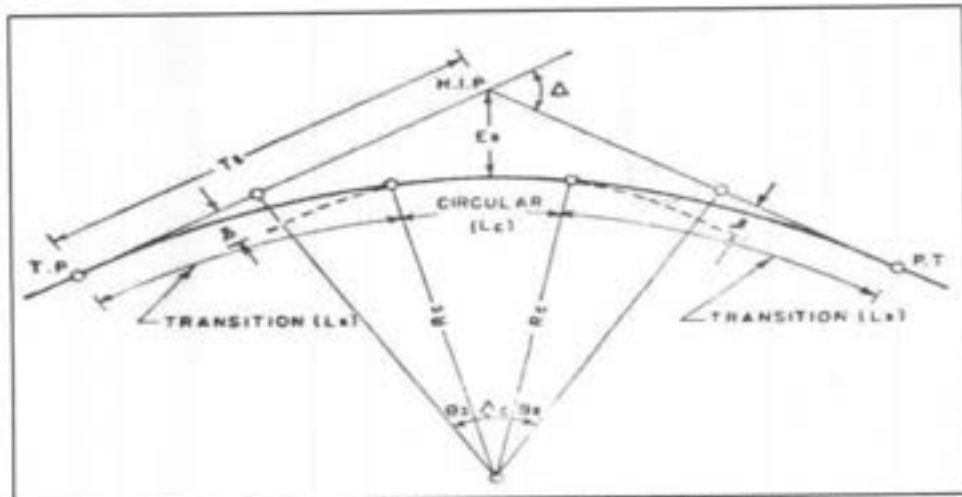

Figure 13: Elements of combined Circular and Transition Curve



Transition point	TP,
Horizontal intersection point	HIP
Total deviation angle	Δ
Deviation and central angle of circular curve	Δ_c
Deviation angle of transition curve	Θ_t
Radius of circular curve	R_c
Shift	s
Tangent distance	T_s
Apex distance	E_s
Length of transition	L_s
Length of circular curve	L_c

Considering the above assumptions, the minimum transition length for different speeds and curve is given in table 9.

Table 9: Length of the Transition Curve

Curve radius, m	Design speed, Km/h				
	10	20	30	40	50
	Transition length, m				
10	30	NA			
20	15	55	NA		
30	NR	40	80	NA	
50		25	50	86	NA
100		15	25	45	70
150		NR	20	30	45
200			15	25	35
250			NR	20	30
300				15	25
400				NR	20
500					NR

NA-Not Applicable; NR-Transition not required

3.7.5. Widening of Carriageway on Curves

It is necessary to widen the carriageway at sharp horizontal curves to provide necessary space for the vehicle. Widening is dependent on curve radius, width of carriageway and type of vehicle (length and width). The following two components necessitate the widening:

- a) Mechanical widening to compensate the extra width occupied by a vehicle on the curve due to off-tracking of wheels,
- b) Psychological widening to permit easy crossing of the vehicles.

Based on the above considerations, the extra width of carriageway to be provided at horizontal curves on single and two-lane roads is given in table 10. For multi-lane roads, the pavement widening may be calculated by adding half the widening for two lane roads to each.

Table 10: Extra width of Pavement at Horizontal Curves

Radius of curves (m)	Up to 20	21 to 40	41 to 60	61 to 100	101 to 300	Above 300
Extra width, m:						
Two lane roads:	1.5	1.5	1.2	0.9	0.6	Nil
Single lane roads:	0.9	0.6	0.6	Nil	Nil	Nil

The widening should be applied equally on both sides of the carriageway. However, the widening should be provided only on the inside when the curve is plain circular and has no transition.

3.8 Gradient

Most urban roads carry mixed traffic including slow moving vehicles like bicycles. Besides this, urban roads generally have intersections at frequent intervals. In view of this, as a general rule, a gradient of 4 percent should be considered the maximum for urban roads. On roads carrying predominantly slow moving traffic, however, the gradient should desirably not exceed 2 percent. At intersections, the road should be as near levels as possible.

The desirable maximum gradient for pedestrian ramps and cycle track are given as follows:

- Pedestrian ramps: 10 percent
- Cycle Tracks: 3 percent

Maximum critical Length of grade.

Where maximum gradient is not possible, maximum length of road with gradient should be limited to following values.

Table 11: Maximum critical Length of Grade

Gradient	4	5	6	7	9	10	12
Maximum critical Length of grade, m	600	450	400	300	200	150	150

In case of gradient more than 4% rigid pavement should be preferred.

Minimum Gradient

As the urban roads are generally kerbed, it is desirable to ensure a minimum gradient as indicated in table 12 for facilitating longitudinal drainage.

Table 12: Recommended Minimum Gradient

Design elements	Gradient, %	
	Desirable minimum, %	Absolute minimum, %
Kerbed pavement	0.5	0.3
Side ditches lined	0.5	0.2

3.9 Design Speed

The design speed is the main factor governing the design of various design features. The design speed should be decided based the importance of the road and the type to terrain. The sight distance, radius of horizontal curve, super elevation, extra widening of pavement, length of transition curve and the length of summit and valley curves all depends on design speed.

Table 13: Recommended Design Speeds for Different Classes of Urban Roads

Type of Road	Design Speed (Km/hr)
Arterial Roads	40-50
Sub Arterial Roads	30-40
Collection Roads	20-30
Local Streets	10-20

3.10 Utilities

Road utilities are required to provide the necessary services to the road and the neighboring areas. Although utilities generally have a little effect on the geometric design of the street, full consideration should be given to measure, reflecting sound engineering principle and economic factor needed to preserve and protect the integrity

and visual quality of the highway of street, its maintenance deficiency and the safety of traffic.

The guiding principles which shall be taken into account for the cross section of an urban road and the utilities that should be considered are as follows.

1. Before working on the plan
2. Implication on cross-section design.
3. Implication on materials and design

There is always a need to accommodate utility service along and across the roads. The laying of utilities shall to be done to ease maintenance and operation but keeping in mind it will affect the traffic flow and conflict with other services to the minimum. Location should be taken up so that minor or no adjustments are required with road works taken up later. These include the following:

1. Sewer Line
2. Storm water drain
3. Water supply lines
4. Electricity cables and Poles
5. Telecommunication cables
6. Gas pipelines
7. Cross conduct ducts and others

3.10.1 Street Lighting

Street lighting enables motor vehicle drivers, cyclists and pedestrians to move safely and comfortable by reducing the risk of traffic accident and improving personal safety. From traffic point of view street lighting is important in potential conflict points such as intersections, driveway and public transportation stops. Additionally, it also helps road users to avoid potholes and missing drain covers. It is also essential for mitigating the pedestrian sense of isolation and reducing the risk of theft and sexual assault. Further, it is equally important in isolation spaces such as under overpass and walkways next to park and blank facades.

Lighting system need regular upkeep in the form of electricity maintenance bulb replacement and dust cleaning in order to remain effective. Following considerations are important for successful street lightning.

- Additional lighting should be provided at junction points.
- The placement of street lighting should be coordinated with other street elements so that tree or advertisement hoardings do not impede proper illumination.
- The spacing between two light poles should be approximately three times the height of the fixture as indicated in the table. The spacing of light poles should be such that black spots should not form.

- Level of illumination in urban road should be minimum 15 lux.
- Poles should not be higher than 12m especially in residential areas they should be significantly lower than 12m to reduce undesirable illumination to private properties.

Table 14: Light pole height and spacing

Street Type	Pole Height (m)	Spacing (m)
Footpath or Cycle track	4-6	12-18
Local street or Collector	9-10	25-30
Arterial or Sub-arterial	10-12	30-35

3.10.2 Storm Water Drainage

Storm water drainage system is a mechanism which prevents water logging and erosion. Streets without storm water drainage system results in major longitudinal storm water flows which may erode the street surface. Such deteriorated surface may cause accident and thus imply costs beyond direct maintenance expenses. In flooded areas pedestrians and cyclists are forced to make their way through uncomfortable and potentially dangerous terrain hidden under the water surface. Usually pedestrians and cyclists are given least priority in a street cross section forcing them to wade through water and mud during the rainy season. The efficient drainage system on street should meet following factors;

- Catch pits should be located at regular intervals, depending on their size, intensity of rainfall and the catchment area and the lowest point of the street cross section.
- The lowest point in the cross section should occur on the carriageway. Cycle tracks footpath bus stops and street vending areas should be at higher level. Drain surfaces should be at grade with the surrounding street surface unless provided in landscaped areas.
- More environmentally friendly approaches such as landscaped swales, improved groundwater recharge, reduced storm water runoff and improved overall live ability of a street should be preferred. Swales range in size from tree pits and landscaping strips to large low lying neighborhood parks. Swales are most appropriate on wide right of way with large areas of unused space but not in constrained environments where they take away space from pedestrians' cyclist and street vendors.
- The number of storm water line should be minimized to keep construction and maintenance cost low.
- Gratings should be designed so that they do not catch cycle wheels.

3.10.3 Underground utilities

The placement of utilities above and below the ground at the appropriate location in the right of way ensures unconstrained movement as well easy access for maintenance. Streets are the conduits for major services including electricity, water, sewer

communication and gas etc. The physical infrastructure may occur in form of pipelines telephone lines and fiber cable ducts and poles. Some utilities such as telecommunications cables require frequent access for expansion and maintenance. Utilities are generally placed at the edge of the right of way. Provisioning of such utilities should follow:

- Underground utilities are ideally placed below the parking area or service lane. If present, this can be dug up easily without causing major inconvenience. The underground utilities can be placed at the outer edge of the right way or footpath if there is a difficulty in placing them under parking space or service lane.
- The ideal approach for deducing conflicts with pedestrian movement is to place utility boxes in easements just off the right of way. Where this is not possible, utility boxes should be placed within parking or landscaping areas. If it is absolutely necessary to locate utilities in the footpath, a space of at least 2m should be maintained for the thorough movement of pedestrians. Utility boxes should never constraint the width of a cycle track.
- Though it is possible to accommodate underground utilities even below a tree line this may lead to the destruction of trees and deterioration in livability if the utilities need to be uncovered. In order to minimize disruption utilities should be installed with proper maintenance infrastructure.

Table 15: Broad recommendation about depth of laying (denoting the bottom of trench) of the various service line are:

Type of Utility	Depth in meter (m)
Trunk Sewer line	2.0-6.0
Water supply line	
• Service line	0.6-1.0
• Trunk line	1.0-1.5
Electric Cable	
• LT Cable	0.6-1.0
• HT Cable	1.5-2.0
Telecommunication Cable	
• Directly laid	0.6-1.0
• Laid in duct	2.0-3.0
Gas Mains and Lines caring combustible materials	2.0-3.0

3.11 Clearances

Clearances are required to be provided for overhanging loads and the tilting of vehicles towards obstruction by cross falls or super elevation of carriageway and for kerb shyness.

3.11.1. Lateral Clearance:

The lateral clearance from edge of pavement should be as follows:

a) Pavement without footpath:

Minimum clearance from the edge of the pavement

Arterial and sub arterial:	1
Collector and local streets:	0.5

b) Pavement with footpath:

No extra clearance beyond the footpath is necessary

c) Clearance on divided carriageway:

The Left side clearance should be followed on the same lines as above. The right side clearance to the face of any structure in the central median shall be as follows:

Arterial and sub arterial:	minimum 1 m from the edge of the pavement
Collector and local streets:	minimum 0.5 m from the edge of the pavement

3.11.2. Vertical Clearance

Minimum vertical clearance of urban roads should be 5 m.

3.12 Traffic Control Devices

These include:

a) Traffic Signs: A "Traffic Sign" means any object, device, line or mark on the road whose object is to convey to road users, or any specified class of road user, restrictions, prohibitions, warnings or information, of any description.

b) Road Marking: The purpose of road markings is to control, warn, or guide, road users. They may be used to supplement other traffic signs or they may be used alone. Their major advantage is that they can give a continuing message to the driver. Thus they can be used to guide drivers in the correct positioning of their vehicles so that the traffic flows smoothly and safely

c) Traffic Signals: Traffic- control signals are the devices that control vehicular and pedestrian traffic by assigning the right of way to various movements for certain pre-timed or traffic-actuated intervals of time.

Unless specified all traffic signs and road markings shall be as per "Traffic Signs Manuals Vol-I and Vol-II" published by the DOR with amendments made thereafter.

4. Cross sectional Element

4.1 Right of Way

The space standards recommended for the various categories of urban roads are given in table 16.

Table 16: Right of Way Width

Classification	Recommended Right of Way Width , m
Arterial	50
Sub-arterial	30
Collector	20
Local	10

4.2 Carriageway Width

The primary purpose of carriageway is vehicle mobility. A carriageway width provides dedicated space for motorized vehicles separated from slow speed modes such as walking and cycling and stationary activities. The width and layout of urban road cross-sections depend on the many factors, the chief amongst them being the classification of roads, design speed, and the volume of traffic expected. Other considerations are requirements of parking lanes, bus-bays, loading- unloading bays, occurrence of access points, volume of pedestrians and cyclist, width of drains, location of sewer lines, electricity cables and other public utility services. Actual width of each element should be based on traffic volumes and other functional requirements. The carriageway should be provided for appropriate speed suited to the street's role in the city's street network. An effective carriageway should have a constant width, thereby, ensuring the smooth flow of vehicles. The width should not increase on stretches where a wider right of way is temporarily available. Wider carriageway segment causes traffic jams where the width narrows down again. The recommended lane width of urban roads is given below.

Table 17: Recommended Carriage Width

Description	Width , m
Arterial and Sub-arterial roads:	
a) Single lane	3.5
b) 2- lane without raised kerb	7
c) 2-lane lane with raised kerb	7.5
d) Multi-lane carriageway, width per lane	3.5
Collector streets:	
a) Single lane	3.5



b) 2- lane without raised kerb	7
c) 2-lane lane with raised kerb	7.5
d) 3-lane with or without kerb	10.5/11.0
e) 4 lane with or without kerb	14
Local street, per lane	3

Note: Minimum width of a kerbed urban road is 5.5 m including allowance for a stalled vehicle.

4.3 Footpath

Footpaths are provided to promote safe and comfortable pedestrian mobility. Together with other element such as road furniture and landscaping they constitute the primary public space of a city and are accessible to all road users regardless of age, gender or special needs. Footpaths are critical elements of streetscape unless traffic calming makes footpath unnecessary. In urban areas footpath should be provided as per the number of pedestrians estimated for future. The minimum clear width of footpath should be 2.0 m, though its width should be preferred to 2.4 m, at least in arterial and sub-arterial road for easy movement of differently-able people. They should have well maintained surface with cross-fall neither so flat as to be difficult to drain nor as steep as to dangerous to walk upon. The cross fall within the range of 2.5 to 3 percent should meet this requirement. Those parts of the footpath immediately adjoining building, fences, trees and other obstruction should be disregarded while calculating widths required. A good footpath should incorporate.

- No breaks or obstructions at property entrances and side streets.
- Continuous shade through tree cover.
- No railing or barrier that prevents sideways movement on and off the footpath.
- Elevation over the carriageway should be equal to +150mm and has adequate cross slope for storm water runoff. At the same time the elevations should be low enough for pedestrians to step on and off the footpath.

The width should be increased by 1 meter in business and shopping areas to allow for the dead width. Footpaths adjoining shopping frontage should be 3.5 m and a minimum of 4.5 m is desirable adjoining longer shopping frontages. At points of possible congestion such as bus stop or entrance of large shops and public building, footpaths may be wider. Where space is available, provision of verge between footpath and carriageway to increase safety of pedestrians is desirable. When deciding the width of footpath and verges, the width required to accommodate under-ground services clear of carriageway should be taken into account. When on slopes or in the case of ramps, the capacity should be suitably reduced.

Table 18 gives the capacity guidelines for designing for footpath.

Table 18: Capacity of Footpaths

Number of Pedestrians per hour		Required width of Footpath, m
All in one direction	In both directions	
2400	800	2
3600	2400	2.5
4800	3200	3
6000	4000	4

4.4 Cycle Track

Cycle tracks should be continuous and provide uninterrupted movement. They are physically separated from the main carriageway to ensure both comfort and safety and are protected from encroachment by parked vehicles, pedestrians and street vendor as shown in the figure. The minimum width of cycle track should be 2 m. Each additional lane where required should be 1 m. Separate cycle tracks should be provided when the peak hour cycle traffic is 400 or more on route with a motor vehicle traffic of 100-200 vehicles per hour. When the number of motor vehicle using the route is more than 200 per hour, separate cycle tracks are justified even if cycle traffic is only 100 per hour.

Table 19: Capacity of Cycle Tracks

Width of Cycle track	Capacity in number of cycles/hour	
	One-way traffic	Two-way traffic
Two lanes (3 m)	250-600	50-250
Three lanes (4 m)	> 600	250-600
Four lanes (5m)	---	> 600

For better efficiency cycle track should incorporate the following:

- Continuity to allow for reasonable speed.
- A smooth surface material, asphalt or concrete paved blocks are to be avoided.
- Manhole covers should be avoided and if unavoidable should be at the same level with the riding surface.
- Continuous shade through tree cover.
- Elevation above the carriageway e.g. +150mm that allows for storm water runoff.
- A buffer of 0.6m between the cycle track and parking area or the carriageway.
- At property access points, the cycle track remains at the same level and vehicle access is provided by a ramp in the buffer.

4.5 Medians & Pedestrian Refuges

Urban highways of six lanes or more should be provided with median. For four lane roads, however, the provision of median should be judicious taking into account such consideration as safety, directional distribution of traffic, quality of service etc. As far as possible, medians or medians should be avoided where there are significant tidal flows of traffic, peak-hour traffic volumes, or where there is intense roadside development without frontage roads. Widths will depend on available right- of-way, terrain, turn lanes, drainage and other determinants. Minimum width of median at intersections to accomplish various purposes should be as follows:

- Pedestrians refuse, 1.2 m.
- Median lane for protection of vehicle making right turn, 4.0 m.
- Absolute width of median in urban areas is 1.2 m a desirable minimum is 5 m.
- Fence or any other barrier medium should be provided at middle of median.

As far as possible, the median should be of uniform width in a particular section. However, where changes are unavoidable, a transition of 1 in 20 must be provided.

In the kerb to kerb carriageway width of 11m or narrower street, periodic pedestrian refuges can enhance safety.

On an artery where the kerb to kerb carriageway width 11m or wider a continuous median surmountable pedestrian max elevation 150mm is recommended.

For the best functioning of safe pedestrian refuge, a minimum width of 1 m to be provisioned while cycle refuge should be 2 m wide.

Guardrails and high kerb are discouraged because they hinder pedestrian and cycle movement. They should be provided only on carriageway with kerb to kerb width of 18 m or larger with a break for pedestrian crossing every 50m.

Adjacent to BRT lanes, longer stretches of guardrail can be provided, with breaks only formal crossing (150-200m)

4.6 Verge

Verges are required between carriageway and property line. It is made not only to accommodate lighting column, traffic signs, underground services etc., but also to provide approaching clearance appropriate clearance to ensure proper vehicle placement and development of full carriageway capacity. Where road width is restricted, full width between carriageway and property line should be paved and used for pedestrian sidewalk/cycle track. Where possible, a minimum verge of 1 m width should be kept. They should be suitably levelled, trimmed and provided with a cross fall of 5 percent if turfed and 3 percent if cobbled or surface dressed. This should be increased if poles, kerb-height, or excessive cross fall discourage parking close to the kerb and also where either parked vehicles frequently overlap on to the adjacent traffic lane or the parking is likely to be used as a peak hour traffic lane.

4.7 Parking Lane

Parking lanes may be provided on all sub-arterial and collector streets in business and shopping areas. Parallel kerb parking should be preferred. Parking lane width for parallel parking should be 3 m which may be reduced to 2.5 m where available space is limited. Where additional parking capacity is desired and sufficient carriageway width is available, angle parking may be adopted.

On street parking is a designated, managed and restricted in volume, enabling access to nearby properties without disturbing the flow of motor vehicle, pedestrians and cyclists.

1. Parking areas should be allotted after providing ample space for pedestrian cyclists, trees and street furniture.
2. Tree pits can be integrated in a parking stretch to provide shade. Otherwise shaded street elements such as footpath may be encroached by parked vehicles.
3. Near intersections, parking lanes can be discounted to reduce conflict and to give additional vehicle \ queuing space.
4. Dedicated cycle parking should be provided at public transport stops and stations in commercial districts.

4.8 Bus-bays & Bus stops

Bus-bays should not be located too close to intersections. It is desirable that they are located at least 40 m from the intersection on either side.

Bus-bays should be provided preferably by recessing the kerb to avoid conflict with moving traffic. The length of the recess should be 15 m for single bus stop with increase of 15 m for each extra bus for multiple bus stops. The taper should be desirably 1:8 but not less than 1:6. Suitable arrangements should be made for drainage of surface water from bus-bays. Sufficient footpath should be ensured behind the bus-bays.

To enable drivers to stop clear of carriageway, lay-byes should be provided at intervals along long straight routes. They should always be provided near guide maps and other public conveniences to enable drivers to stop clear of carriageway. They should normally be 3 m wide and at least 30 m long with 15 m end tapers on both sides. Suitable arrangements should be made for drainage of surface water from lay-byes.

Bus stops should be the interface between the street and a city's public transport system. Spacing in busy commercial districts is typically closer than in residential areas interval between stops range from 200-400 m. Stops should be located near cross streets and always provide safe pedestrian crossing.

Bus stops should be placed adjacent to the bus linear line of travel so that the bus does not need to pull over to the left. Ideally a raised bus stop is integrated with the footpath and other raised elements so that passengers can reach the stop and boards the bus directly from the footpath without needing to steps into the carriageway.

4.9 Kerbs

Kerbs shall be provided in Urban roads considering appropriate situation for use of each type as indicated below:

- a) Mountable type: within the roadway at channelization schemes, medians, outer separators and raised medians on bridges
- b) Semi-barrier type: on the periphery of the roadway where pedestrian traffic is light and a barrier type could tend to reduce traffic capacity.
- c) Barrier type: Built-up areas adjacent to footpaths with considerable pedestrian traffic.

4.10 Camber

Camber should be adopted as follows for straight sections:

Table 20: Recommended Camber

Surface Type	Camber, %
WBM or gravel	2.5 to 3.5 %
Thin bituminous surfacing	2 to 2.5 %
High type bituminous surfacing or Cement concrete surfacing	1.5 to 2 %

Higher values of camber should be adopted in areas with high intensity of rainfall and where water is expected to pond in local depressions due to unequal settlement. Steeper camber should also be provided on kerbed pavements to minimize the spread of surface water flows.

4.11 Pedestrian Crossing

Pedestrian crossing should allow pedestrians to cross busy street safely and conveniently. The pedestrian crossings should be indicated by painted zebra markings.

Raised cross space walks should be elevated to the level of the adjacent footpath (150-200mm above the road surface) with ramps for motor vehicles. The slope for vehicle should be at least 1:4.

Raised crosswalk should be located at all intersections (both signalized and uncontrolled) and at frequent intervals (e.g. every 150-200m)

Crosswalks should be as wide as the adjacent footpath and never narrower than 2m. Where fences are installed to prevent crossing informal crossing in the form of breaks in the fencing should be provided wherever there is demand. The fence should be discontinued for at least 2m in order to create a refuge island so that pedestrians do not spill over in to the main carriageway. Given the opportunities for informal crossing, that

opportunities for informal crossing should be given rather frequently, no treatment in the main carriageway should be given.

At formal and informal crossing, parking lanes should be converted to bulb-outs to reduce the crossing distance.

4.12 Traffic Calming Elements

Traffic calming elements should ensure pedestrian and vehicle safety by reducing the speed and volume of motor vehicle. Such elements are particularly important in places where large numbers of children are present such as school, parks and residential areas. As consequences to the noncompliance with zebra crossing and even traffic light, the most effective way to increase safety of non-motorized users is to slow down the motorized traffic forcibly through physical measures such as speed humps, raised speed tables and bollards.

Traffic calming slows down vehicle through one of the following mechanisms: vertical displacement, horizontal displacement, real or perceived narrowing of the carriageway material colour change that signals conflict points or the complete closure of a street. Traffic calming can take different forms depending on the context, and is more effective where two or more mechanisms are combined. The most commonly used element being road speed humps and raised pedestrian crossing which rely on vertical displacement to reduce speed. Some considerations for traffic calming are:

- No restrictions of pedestrians and cycle connectivity.
- Traffic and pedestrian volumes.
- Frequency and type of accident.
- Road and carriageway width or intersection size.
- Traffic mode to be calmed for example a street might be closed to cars but left open for cyclists and pedestrians.

4.13 Bus Rapid Transit (BRT)

Bus Rapid Transit (BRT) offers higher capacity and high quality public transport at a lower cost by providing an exclusive right of way for BRT buses. BRT brings competitive travel time and reliable scheduling in road based public transport. It is a financially viable option for providing high quality public transportation service to a majority of urban residents in a short time span. BRT on median bus lanes also improves safety for cyclists by eliminating conflict points at bus stops. A BRT system should satisfy following:

- Exclusive bus lanes shall be provided in the centre of the street except on small streets where mixed traffic runs as one way only on one side of the street.
- The width of BRT lane is 3.3m plus buffer space next to mixed traffic.
- At crossing a 1 m pedestrian refuge between mixed traffic and BRT lane is needed.

- Centrally locate BRT stations require 3 m (preferably 4 m) in cross section. Large width may be required if demand is high.
- Safe pedestrian access via cross walks elevated to the level of the footpath e.g. +150mm.
- Stations should be placed 40 m or, more off intersection stop lines to allow sufficient space for bus and mixed traffic queues.
- To achieve higher capacities as those of metro system passing lanes substations and express services are required at BRT stations.
- Cycle parking is needed at stations

4.14 Landscaping Design & Aesthetics

Landscaping improves the livability and enhances the aesthetic qualities of street. It plays a functional role in providing shade to pedestrians, cyclists, vendors and public transport passengers. Effective greening with street trees reduces the street temperature making it comfortable for people to walk, cycle or gather for social activities. It also promotes sense of ownership among nearby residents or shop owners towards upkeep. It can also incorporate fruit bearing and medicinal or religious trees and shrubs. Landscaping should address the followings:

- Appropriate distance between trees to provide continuous shade; depend on individual trees, canopy size and shape. In dry climate where do not grow very fast closer spacing is necessary.
- The pits location should be coordinated with the position of street light.
- Medium height vegetation should be trimmed directly adjacent to formal crossing to improve the visibility of pedestrian and cyclists.
- Trees with high branching structure are preferable.
- Tree pits should have dimensions of at least 1m by 1m to accommodate roots at full maturity. On narrow sidewalks the same surface area can be achieved with 0.5m by 2m tree pits. Hume pipes can lower the level at which roots spread out, thereby reducing damage to road surfaces and underground utilities.

4.15 Grade separated Junctions & Facilities

At junction's grade separation between different modes either for bicyclist and pedestrians or more arms of vehicular traffic may be proposed to reduce complexity and increase safety. Careful analysis of requirements and suggested alternatives shall be undertaken before opting for such solutions.

The ideal situation on urban road is where the pedestrian does not have to change level and in planning new facilities this should be seriously considered. In case a level change in needed to be accommodated the following options may be followed;

4.15.1 Pedestrian Subway

A pedestrian subway is usually provided in those places where there is high volume of traffic and it is not considered efficient to use signal intermittently stop the traffic flow.

Half subways- In such subways both the car lane users and the pedestrians (including cyclists, wherever segregated facility is provided) need to have a change in level. The car lanes are raised (+1.5m) using a ramp of 1:30 and the pedestrian paths (cycle tracks, wherever provided) are lowered using ramps of slope 1:20 with landing at appropriate intervals to equally achieve a clear minimum height of 2.75m. (-1.5m). The advantage of such subways is that the walking length of a pedestrian is not increased to the extent that it discourages him from using it.

Full subways- In this case, the pedestrian paths are lowered to a depth where a clear height of 2.75m minimum can be achieved using 1:20 slope ramps with appropriate landings. The car lanes encounter no level change and maintain the same level.

4.15.2 Pedestrian Overhead Bridges

Foot-over bridges increase the walking length of a commuter for access, which is inconvenient. Such facilities need to be inclusive too. To make inclusive pedestrian facility, ramp (gradient 1:20 with landing at adequate intervals), lifts and steps (landings at an appropriate levels) can be provided. Escalators are not inclusive measure.

Introduction of facilities would lead to a compromised arrangement of NMV and pedestrian track leading to sub optimal conditions if there is restricted ROW.

To make the grade separated measures more inclusive, following key features shall be considered:

- The approaches to footbridges and underpasses shall comprise ramps/elevator, steps and handrails, except that in the underpass situation the width should be as generous as possible to provide an open aspect.
- A slope of 8% (1 in 12) of footbridge ramps, where a slope of 5% (1 in 20) with appropriate resting place is preferable.
- Within the underpass, a handrail at 850mm-900mm above the waling surface should be provided. To assist visually impaired people, warning tiles and, if possible, a color contrast should be provided at the top and bottom of every flight of steps.
- The top and bottom steps should be brightly colored and these areas should be well lit.

Elevator/lift should be provided on both the entrances. Exits and entries should have minimum internal dimensions of 1400 mm x 1400 mm.

4.15.3 Grade Separated NMV Crossing

The following three main criteria shall be considered for the grade separated NMV crossing:

Location, Type and Geometric Elements.

Location:

At NMV junctions on arterial road where high vehicular volume and speed results in higher risks for bicyclists and lesser priority to crossing bicycle traffic a grade separated crossing facility may be preferred for cyclists and pedestrians to reduce their delays and increase safety. Grade separated crossing may be provided at major signalized intersections, roundabouts and other un-signalized locations where crossing of only bicyclists and pedestrians is to be allowed and at grade crossing is considered unsafe and inefficient. These are mid-block locations where vehicle (right) turning is not permitted and the junction is signal free left turn only. Other reason that may warrant the need for grade separation as against a NMV and pedestrian only signalized crossing are:

- To avoid interruption to vehicular traffic and reduce the risk of off peak hour accidents at signalized crossing.
- To discourage possible misuse of turning restrictions, by more flexible motorized modes such as two wheelers.

NMV path junctions with collector or access roads do not require grade separated provisions for crossing/turning cyclists as lower vehicular volumes and speeds are expected. Lower vehicular speeds and volumes at intersections allow junction designs where bicyclist requirements are balanced or prioritized over motor vehicles, while at mid blocks this results in gaps in the traffic stream allowing safer crossing for NMVs and pedestrians.

Wherever provided grade separated crossing should be aligned to the natural crossing or turning path of the cyclists, leading to higher directness and shorter journey time.

Type:

Grade separated crossing for NMVs can be either elevated (over pass/ bridge) or depressed (underpass/ tunnel) from the road level. Though both overpasses and underpasses have both advantages and disadvantages, it needs to be assessed from the point of site conditions and its surroundings. However purely from the point of view of NMV requirement of comfort, directness and coherence and underpass is more appropriate option than an over pass.

Geometric elements:

An underpass or an overpass for NMVs shall have the elements to ensure directness, safety and comfort to its users. The salient design features of these elements are:

- a) Access: the access to NMV underpass or an overpass should ensure that directness and coherence of the user is not compromised. It should be directly aligned to the NMV path and should include minimum or no detours from the mainstream cycling

route. Other important features that should be considered while designing the access of a NMV over or an under pass are.

- It is necessary to ensure that NMV users can visually connect and identify in time, an access to an underpass or an overpass on their approach to the infrastructure. The distance shall be calculated on the basis of 2-3 seconds for reading, 2-3 seconds for understanding a 2-3 seconds to take corrective action in route and direction adjustments. As the speed of NMV ranges up to 20 Km/hr a grade separated infrastructure access (or the location where a bridge/ tunnel access splits from main cycling route) for NMVs should be identifiable from a distance of 50m to 60m along a bicycling path.
- A grade separated bicycling infrastructure along a mainstream cycling route should not be gated or controlled against NMV access at any point in time.
- Access control to prevent misuse by motorized vehicles effectively signposted and marked to ensure its visibility from the desired distance.
- NMV ramps should be designed as per minimum gradient requirement.
- All surfaces should satisfy appropriated level of surface friction and adequate care shall be made while selecting the material to avoid slippery condition during normal and wet weather.
- NMV grade separator infrastructure including its access should be designed with due consideration to surface drainage in order to avoid puddles and slippery condition.

Clear width:

The width of the under pass or a bridge / overpass shall have dimensions taking into account shy away distances from walls and railings. All tunnels and bridges should preferably be supporting two-way movement of NMVs. It is also desirable to combine NMV and pedestrian crossing infrastructure into a single underpass or over pass. In such case suitable additional width shall be provided for the expected two-way volume of pedestrian traffic. Pedestrian path shall be defined distinctly from NMV path using color, texture or level differences.

Edges:

Following features shall be considered while constructing the edges of under pass or over pass/bridges for the safety, comfort and attractiveness of NMVs:

- Bicycle railing on bridges and ramps shall be provisioned to prevent cyclists from falling over. The railing height shall be higher than 85 percentile of the height of the center of gravity of cyclists. A desirable height of 1.4 m shall be provided. (US standard)
- Shy away distances from blank walls and other obstructions as per requirement shall be marked or paved accordingly. Locations where pedestrians also share underpass, the shy away distance and additional width shall be allocated to pedestrian facility as a 75 mm raised path.
- Handrails shall be provided for pedestrians, especially disabled users. Two hand rails, one at a height of 0.95m for walking pedestrians and the other at a height of



0.75 m for wheelchair users should be provided in the tunnel and on the access ramps. The handrails shall be 45 to 55 mm in diameter and Additional Consideration for Strategic Road passing through Urban Road shall be provided on both sides of the grade separator and its ramps.

- The spacing between the railing and members of the guards shall prevent small objects from falling through.

4.15.4 Grade separated Vehicular Junctions

Grade separators may be used to segregate fast moving highway or express way traffic moving across parts of the city. NMV movement along such road shall be segregated from motorized traffic.

5. Additional Consideration for Strategic Road passing through Urban Road

Highways and strategic roads passing through the urban areas should consider and meet the following requirements.

5.1 Noise barriers

As the highways and high speed roads have higher level of noise. Therefore, following noise barriers should be provided to isolate any nearby densely populated area.

- Humps
- Perforated screens
- Green belts

5.2 Light barriers

As the highways and high speed roads have higher level of unwanted light through-out the day,

Therefore, following light barriers should be provided to isolate any nearby densely populated area.

- Humps
- Perforated screens
- Green belts

5.3 Approach Facilities

Avoid sudden meeting of local roads and highways, certain transitional road is required for the sake of achieving safety of the local road users as well as to maintain required speed in highway well design approach facilities should be provided.

- Service roads
- Separate approach roads

5.4 Crossing Facilities

High volume and high speed traffic in the highways causes the disruption between the neighborhoods by the side of the highway. To facilitate the communication and transportation between these two neighborhoods, non-motorized and pedestrian should be provided at interval of not more than 500 m in densely populated area and 1 km. in less populated area. It could be flyover and underpass. In designing flyover wheel chair accessibility and in underpass public security should be considered.

5.5 Consistency of Standards

Consistency of standard shall be maintained over reasonable distance of 5 km to 15 km to reduce the risk of accidents. The designer should also try to ensure that speed on successive stretches do not differ by more than 15 km/hr.

5.6 Relaxation of Road Design Standard

These standards may be relaxed by GoN to meet special circumstances such as very difficult terrain condition and/or high cost involvement in the construction. Where minimum design standard cannot be adopted due to high cost involvement, sufficient traffic safety measures shall be adopted.

6. Glossary

- Adverse Cross fall:** A slope on a curved pavement which generates forces detracting from the ability of a vehicle to maintain a circular path.
- Alignment:** The geometric form of the centre line (or other reference line) of a carriageway in both the horizontal and vertical directions.
- Arterial Road:** A road with a prime function to provide for major regional and inter-regional traffic movements.
- Auxiliary Lane:** A portion of the carriageway adjoining the through traffic lanes, used for purposes supplementary to the through traffic movement.
- Barrier:** An obstruction placed to prevent vehicle access to a particular area.
- Barrier Kerb:** A kerb with a profile and height sufficient to prevent or discourage vehicles moving off the carriageway
- Carriageway:** That portion of a road or bridge devoted particularly to the use of vehicles, inclusive of the shoulders and auxiliary lanes.
- Centre line:** The basic line which defines the axis or alignment of the centre of a road or other works.
- Clearance:** The space between a moving and a stationary object.
- Cross fall:** The slope, measured at right angles to the alignment, of the surface any part of a carriageway.
- Crown:** The highest point on the cross section of carriageway with two-way cross fall.
- Cycle Lane:** A paved area adjacent to and flush with the traffic lane pavement for the movement of cyclists.
- Design Speed:** A minimal speed fixed to determine the geometric features of a road.
- Design Vehicle:** A hypothetical road vehicle whose mass, dimensions and operating characteristics are used to determine geometric requirements.
- Drainage:** Natural or artificial means for the interception and removal of surface of subsurface water.
- Footpath:** A public way reserved for the movement of pedestrians and manually propelled vehicles.
- Formation:** The surface of the finished earthworks, excluding cut or fill batters.
- Grade:** A length of carriageway sloping longitudinally. The rate of longitudinal rise (or fall) of a carriageway with respect to the horizontal, expressed as a percentage. The objective is:
- To design the longitudinal profile of a road.
 - To secure a predetermined level or inclination to a road or other surface.
 - To shape or smooth an earth, gravel, or other surface by means of a grader of similar implement.
 - To mix aggregates according to a particle size distribution.
- Grade Separation:** The separations of road, rail or other traffic so that crossing movements, which would otherwise conflict, are at different elevations.

- Horizontal Curve:** A curve in the plan or horizontal alignment of a carriageway.
- Interchange:** A grade separation of two or more roads with one or more interconnecting carriageways.
- Intermediate Sight Distance:** A distance, adopted for reasons of economy, which models an overtaking vehicle completing, or aborting, an overtaking maneuver before reaching an opposing vehicle.
- Intersection:** A place at which two or more roads at grade or with grade separation.
- Intersection Angle:** An angle between two successive straights on the centre line of a carriageway. The angles between the centre lines of two intersecting carriageways.
- Intersection (at-grade):** An intersection where carriageways cross at a common level.
- Intersection Leg:** Any one of the carriageways radiating from and forming part of an intersection.
- K Value:** The constant rate of change of grade of a parabolic vertical curve expressed as a percentage.
- Kerb:** A raised border of rigid material formed at the edge of a carriageway.
- Kerb Clearances:** A distance by which the kerb should be set back in order to maintain the maximum capacity of the traffic lane.
- Lane (Traffic):** A portion of the paved carriageway marked out by kerbs, painted line or barriers, which carries a single line of vehicles in one constant direction.
- Lane Separator:** A separator provided between lanes carrying traffic in the same direction to discourage or prevent lane changing, or to separate a portion of a speed change lane from through lanes.
- Lateral Friction:** The force which, when generated between the tyre and the road surface assists a vehicle to maintain a circular path.
- Level of Service (LOS):** A qualitative measure describing operational conditions within a traffic stream and their perception by motorists and passengers.
- Line of Sight:** The direct line of uninterrupted view between a driver and an object specified height above the carriageway in the lane of travel.
- Longitudinal Friction Factor:** The friction between vehicle tyres and the road pavement measured in the longitudinal direction.
- Longitudinal Section:** A vertical section, usually with an exaggerated vertical scale, showing the existing and design levels along a road design line, or another specified line.
- Median:** A strip of road, not normally intended for use by traffic, which separates carriageways for traffic in opposite directions.
- Median Island:** A short length of median serving a localized purpose in an otherwise undivided road.
- Median Opening:** A gap in a median provided for crossing and turning traffic.
- Normal Cross Section:** The cross section of the carriageway where it is not affected by super elevation or widening.
- One-way Road:** A road/street on which all vehicular traffic travels in the same direction.



- Over taking:** The maneuver in which a vehicle moves from a position behind to a position in front of another vehicle travelling in the same direction.
- Overtaking Distance:** The distance required for one vehicle to overtake another vehicle.
- Pavement:** That portion of a road designed for the support of, and to form the running surface for, vehicular traffic.
- Property Line:** The boundary between a road reserve and the adjacent land.
- Rate of Rotation:** The rate of rotation required to achieve a suitable distance to uniformly rotate the crossfall from normal to full super elevation. The usual value adopted is 0.025 rad/sec; 0.035 rad / sec is the maximum value.
- Reaction Distance:** The distance travelled during the reaction time.
- Reaction Time:** The time between the driver's reception of stimulus and taking appropriate action.
- Re-alignment:** An alteration to the control line of a road which may affect only its vertical alignment but, more usually, alters its horizontal alignment.
- Reverse Curve:** A section of road alignment consisting of two arcs curving in opposite directions and having a common tangent point or being joined by short transition curve.
- Road (way):** A route trafficable by motor vehicles; in law, the public right-of-way between boundaries of adjoining property.
- Roundabout:** An intersection where all traffic travels in one direction around a central island.
- Rural road:** Normally a sealed unkerbed road with free draining pavement and table drains instead of gutters. In urban areas, rural type roads may be provided where there is no adjacent urban development. The term rural road does not imply "low standard" road or "short life" road. If such requirements exist, they are explicitly specified by the Client.
- Sag Curve:** A concave vertical curve in the longitudinal profile of a road.
- Shoulder:** The portion of formed carriageway that is adjacent to the traffic lane and flush with the surface of the pavement.
- Sideways Friction Co-efficient:** The ratio of the resistance to sideways motion of the tyre of a vehicle (on a specified pavement) and the normal force on that wheel due to the vehicle mass.
- Sight Distance:** Approach Sight Distance: The distance required for a driver to perceive marking or hazards on the road surface and to stop.
- Car Stopping Distance:** The distance required for a car driver to perceive an object on the road and to stop before striking it.
- Entering Sight Distance (ESD):** The sight distance required for minor road drivers to enter a major road via a left or right turn, such that traffic on the road is unimpeded.
- Maneuver Sight Distance:** The distance required for an alert car driver to perceive an object on the road and to take evasive action.
- Overtaking Sight Distance:** The sight distance required for a driver to initiate and safely complete an overtaking maneuver.

Railway Crossing Sight Triangle: The clear area required for a truck driver to perceive a train approaching an uncontrolled railway crossing and to stop the truck.

Safe Intersection Sight Distance: The distance required for a driver in a major road to observe a vehicle entering from a side road, and to stop before colliding with it.

Sight Distance through Underpass: The distance required for a truck driver to see beneath a bridge located across the main road, to perceive any hazard on the road ahead, and to stop.

Truck Stopping Sight Distance: The distance required for a truck driver to perceive an object on the road and to stop before striking it.

Skid Resistance: The frictional relationship between a pavement surface and vehicle tyres during braking or cornering maneuvers. Normally measured on wet surfaces, it varies with the speed and the value of 'slip' adopted.

Slope: The inclination of a surface with respect to the horizontal, expressed as rise or fall in a certain longitudinal distance.

Stopping Sight Distance: The sight distance required by an average driver, travelling at a given speed, to react and stop.

Sub-arterial Road: Road connecting arterial roads to areas of development, and carrying traffic directly from one part of a region to another.

Super elevation: A slope on a curved pavement selected so as to enhance forces assisting a vehicle to maintain a circular path.

Super elevation Development: The area in which the transverse slopes on a carriageway are gradually changed from normal cross fall to super elevation.

Table Drain: The side drains of a road adjacent to the shoulder, having its invert lower than the pavement base and being part of the formation.

Terrain: Topography of the land.

Traffic: A generic term covering all vehicles, people, and animals using a road.

Traffic Island: A defined area, usually at an intersection, from which vehicular traffic is excluded. It is used to control vehicular movements and as a pedestrian refuge.

Traffic Lane: A portion of the paved carriageway marked out by kerbs, painted line or barriers, which carries a single line of vehicles in one constant direction.

Traffic Sign: A sign to regulate traffic and warn or guide drivers.

Transition Curve: A curve of varying radius used to model the path of a vehicle as the driver moves the steering wheel from straight to a horizontal curve of constant radius.

Typical Cross Section: A cross section of a carriageway showing typical dimensional details, furniture locations and features of the pavement construction.

Verge: That portion of the formation not covered by the carriageway or footpath.

Vertical Alignment: The longitudinal profile along the centerline of a road.

Vertical Curve: A curve (generally parabolic) in the longitude profile of a carriageway to provide for a change of grade at a specified vertical acceleration.



7. References

1. AASHTO: A policy on Geometric Design of Highways and Streets, Washington DC, 2001
2. UNESCAP: Asian Highway Handbook, United Nations, New York, 2003
3. IRC 64: Guidelines for capacity of Roads in Rural Areas, New Delhi, 1990
4. IRC 73: Geometric Design Standards for Rural (Non-urban)- Highways, New Delhi, 1980
5. SNIP 2.05.08: Awtomobilnye Dorogi (Russian Roads Standards), Moscow, 2008
6. Do R: Nepal Roads Standards (2027): First Revision 2045, BS
7. DoR : Nepal Roads Standard 2070, Kathmandu, 2013
8. Do R: Design Standards for Feeder Roads, Third Revision, Kathmandu, 1997
9. DoLIDAR: Nepal Rural Road Standards (2055), Kathmandu, 2012
10. TRRL: ORN6 A Guide to Geometric Design: Crowthorne Berkshire United Kingdom, 1988
11. MIR Publishers: Babkov V F: Design of Highways(in Russian), Transport, Moscow, 1985
12. DoR: Traffic Signs Manuals Vol-I and Vol -II, Kathmandu, 1997
13. CL Engineering/Cengage Learning India: Garber and Hoel: Principles of Traffic And Highway Engineering, New Delhi, 2010
14. Khanna Publishers: Kadiyali and Lal: Principles and Practices of Highway Engineering (4th Edition), New Delhi, 2005